

LT4B-5 [12V2.3Ah]

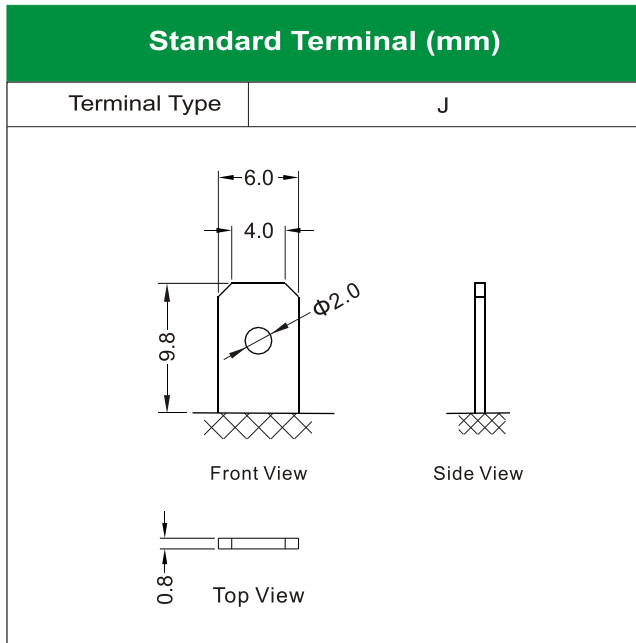
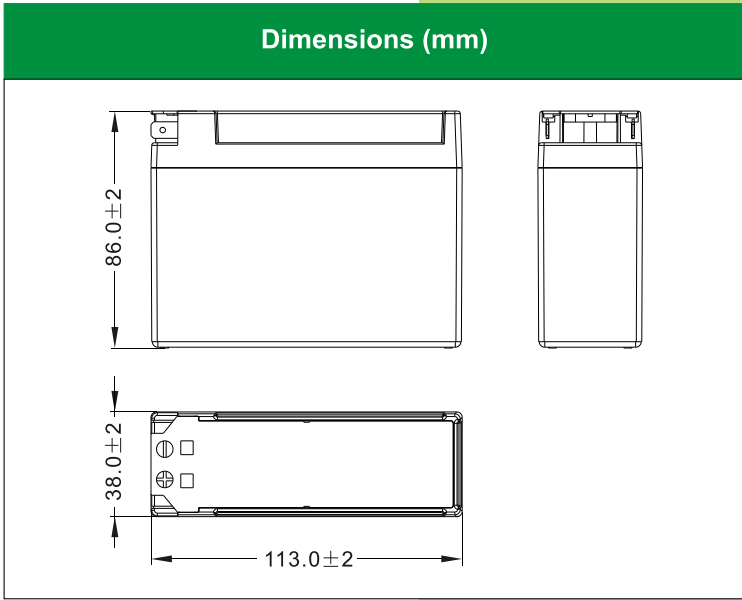

Physical Specification

Nominal Voltage	12V	
Nominal Capacity (10HR)	2.3AH	
Dimension	Length	113 ± 2mm (4.45 inches)
	Width	38 ± 2mm (1.50 inches)
	Container Height	86 ± 2mm (3.39 inches)
	Total Height (with Terminal)	86 ± 2mm (3.39 inches)
Weight	Battery(with acid): Approx 0.91kg (2.00lbs)	
	Electrolyte: Approx 0.14kg (0.31lbs)	

- * Sealed and non-spillable AGM battery
- * Maintenance-free
- * Powerful 40 cold cranking amps
- * Shipped pre-charged and ready to install
- * Replaces LT4B-BS battery

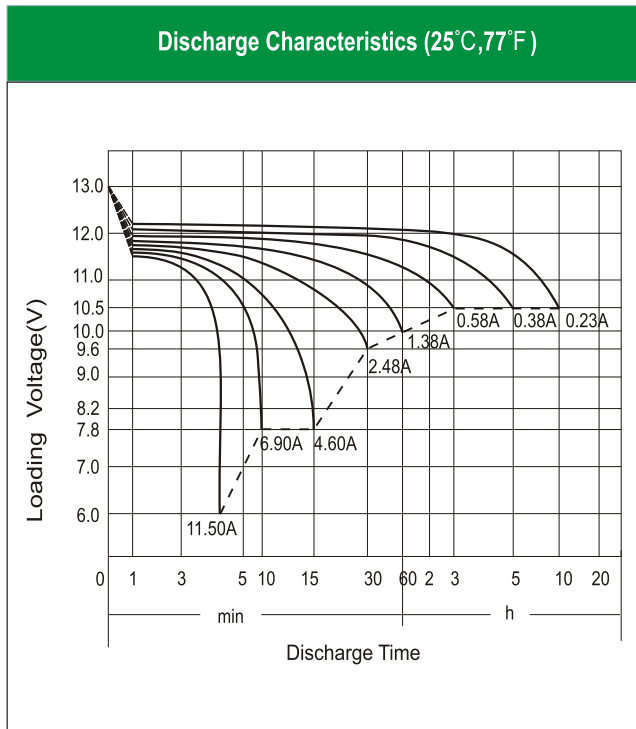

Electrical Specification

Rated Capacity	10 hour rate (0.23 A)	2.30AH
	5 hour rate (0.38 A)	1.89AH
	2 hour rate (0.81 A)	1.61AH
	1 hour rate (1.38 A)	1.38AH
	0.5 hour rate (2.48 A)	1.24AH
Capacity affected by Temperature	40 °C (104 °F)	106%
	25 °C (77 °F)	100%
	0 °C (32 °F)	86%
	-15 °C (5 °F)	65%
Self Discharge	Approximately 3% per month (25°C (77°F))	
Charging Methods	Full Charge	Constant-Voltage Charge: Initial charging current: less than 0.69A Voltage: 14.40 V ~ 15.00 V at 25 °C (77 °F) Charging time: 15 ~18h Constant-Current Charge: Charging current: 0.1C ₁₀ =0.23A, when charging voltage up to 14.40V, continue to charge 4h
	Floating Charge	No limit on Initial charging current Voltage: 13.50 V ~ 13.80 V at 25 °C (77 °F)