

6N6-1D [6V6Ah]

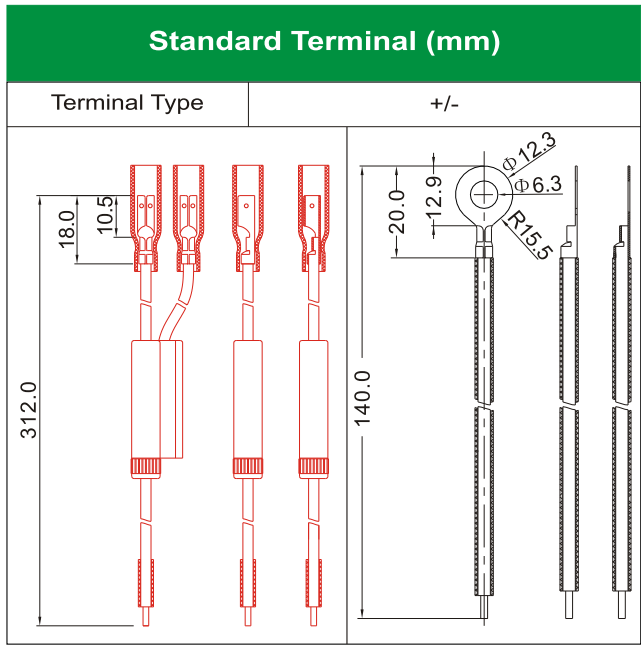
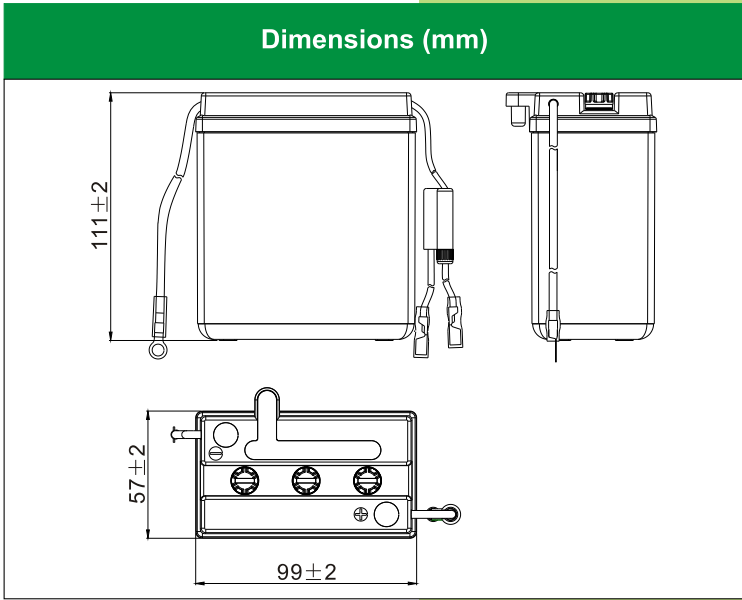
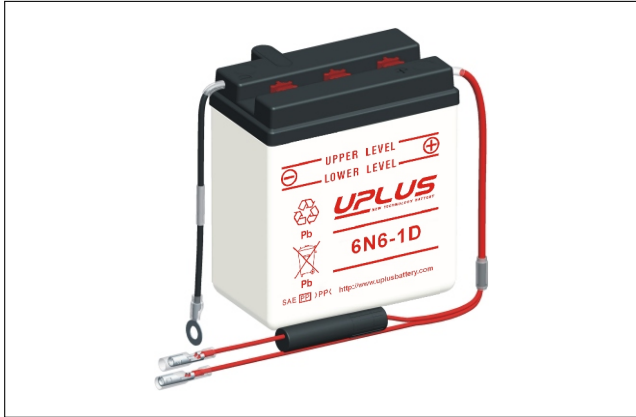

Physical Specification

Nominal Voltage	6V	
Nominal Capacity (10HR)	6AH	
Dimension	Length	99±2mm (3.90 inches)
	Width	57±2mm (2.24 inches)
	Container Height	111±2mm (4.37 inches)
	Total Height (with Terminal)	111±2mm (4.37 inches)
Weight	Battery(with acid): Approx 1.19kg (2.62lbs)	
	Electrolyte: Approx 0.33kg (0.73lbs)	

- * High performance and dry charged high quality and flooded battery
- * Low maintenance
- * Shipped without battery electrolyte pre-charged and ready to install
- * Replaces none battery

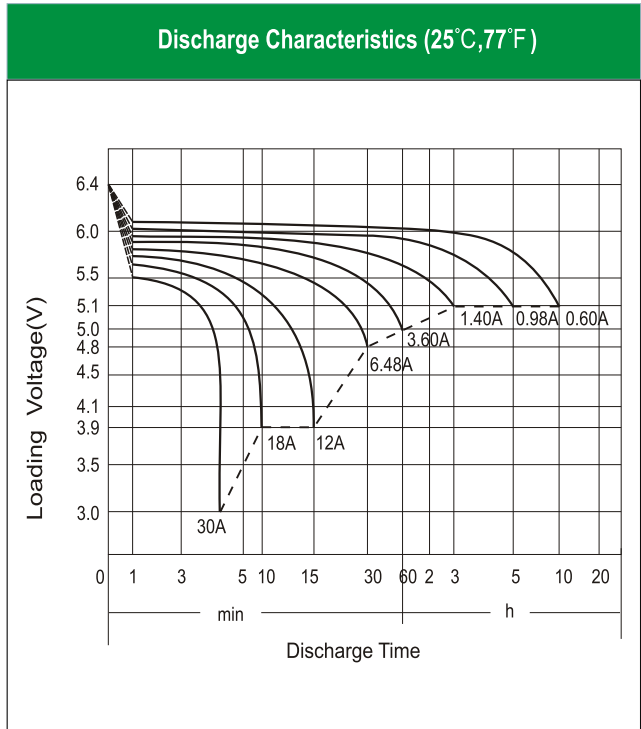

Electrical Specification

Rated Capacity	10 hour rate (0.60A)	6.00AH
	5 hour rate (0.98 A)	4.92AH
	2 hour rate (2.10 A)	4.20AH
	1 hour rate (3.60 A)	3.60AH
	0.5 hour rate (6.48 A)	3.24AH
Capacity affected by Temperature	40 °C (104 °F)	106%
	25 °C (77 °F)	100%
	0 °C (32 °F)	86%
	-15 °C (5 °F)	65%
Self Discharge	Approximately 12% per month (25°C (77°F))	
Charging Methods	Full Charge	Constant-Voltage Charge: Initial charging current: less than 1.8A Voltage: 7.20 V ~ 7.50 V at 25 °C (77 °F) Charging time: 16 ~24h Constant-Current Charge: Charging current: 0.60A, when charging voltage up to 7.80V, continue to charge 2h.
	Floating Charge	No limit on Initial charging current Voltage: 6.75V ~ 6.90 V at 25 °C (77 °F)