

# 6N4B-2A-4 [6V4Ah]

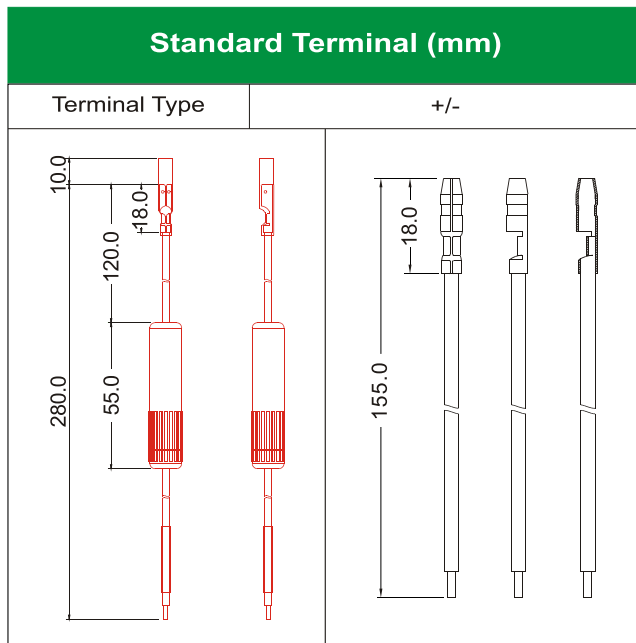
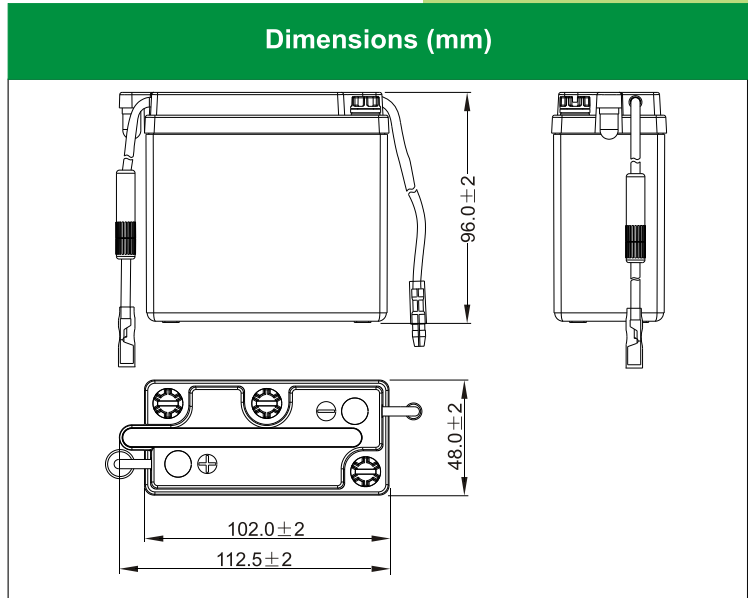

### Physical Specification

Nominal Voltage	6V	
Nominal Capacity (10HR)	4AH	
Dimension	Length	102 ± 2mm (4.02 inches)
	Width	48 ± 2mm (1.89 inches)
	Container Height	96 ± 2mm (3.78 inches)
	Total Height (with Terminal)	96 ± 2mm (3.78 inches)
Weight	Battery(with acid): Approx 0.87kg (1.92lbs)	
	Electrolyte: Approx 0.25kg (0.55lbs)	

- \* High performance and dry charged high quality and flooded battery
- \* Low maintenance
- \* Shipped without battery electrolyte pre-charged and ready to install
- \* Replaces none battery

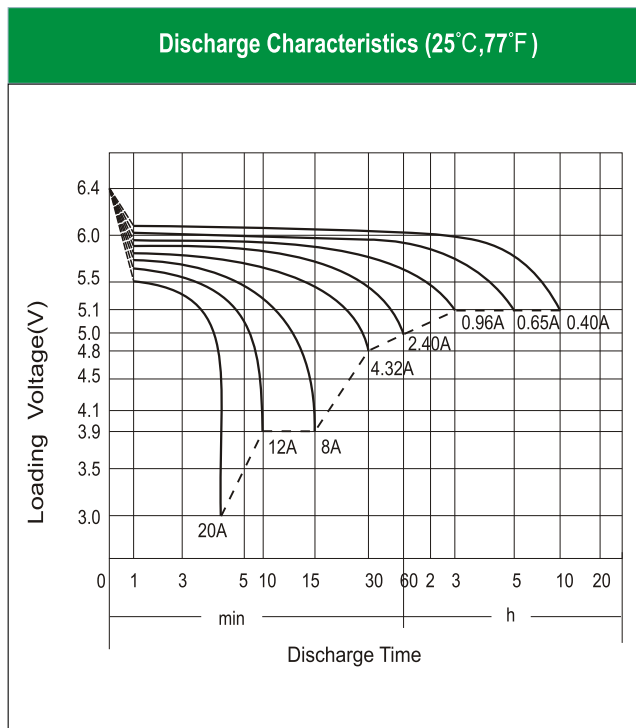

### Electrical Specification

Rated Capacity	10 hour rate (0.40A)	4.00AH
	5 hour rate (0.65A)	3.28AH
	2 hour rate (1.40 A)	2.80AH
	1 hour rate (2.40 A)	2.40AH
	0.5 hour rate (4.32 A)	2.16AH
Capacity affected by Temperature	40 °C (104 °F)	106%
	25 °C (77 °F)	100%
	0 °C (32 °F)	86%
	-15 °C (5 °F)	65%
Self Discharge	Approximately 12% per month (25°C (77°F))	
Charging Methods	Full Charge	Constant-Voltage Charge: Initial charging current: less than 1.2A Voltage: 7.20 V ~ 7.50 V at 25 °C (77 °F) Charging time: 16 ~24h Constant-Current Charge: Charging current: 0.4A, when charging voltage up to 7.80V, continue to charge 2h.
	Floating Charge	No limit on Initial charging current Voltage: 6.75V ~ 6.90 V at 25 °C (77 °F)