

# 12N7A-4A [12V7Ah]

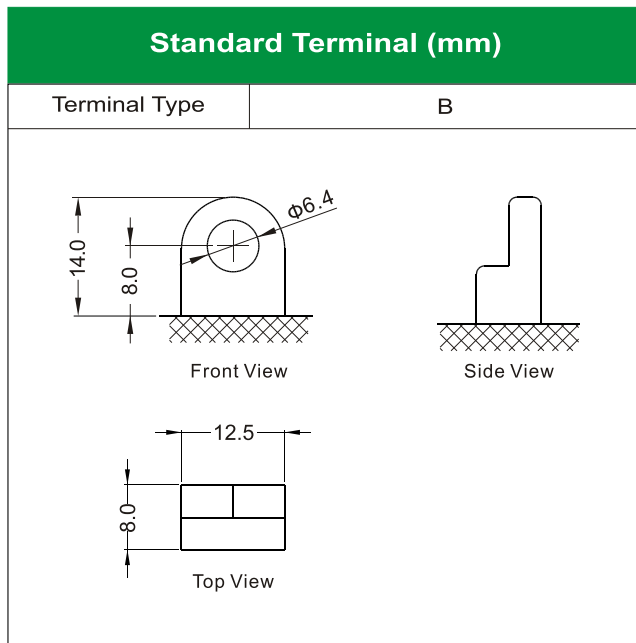

### Physical Specification

Nominal Voltage	12V	
Nominal Capacity (10HR)	7AH	
Dimension	Length	150 ± 2mm (5.91 inches)
	Width	60 ± 2mm (2.36 inches)
	Container Height	130 ± 2mm (5.12 inches)
	Total Height (with Terminal)	130 ± 2mm (5.12 inches)
Weight	Battery(with acid): Approx 2.63kg (5.79lbs)	
	Electrolyte: Approx 0.63kg (1.39lbs)	
<ul style="list-style-type: none"> <li>* High performance and dry charged high quality and flooded battery</li> <li>* Low maintenance</li> <li>* Powerful 70 cold cranking amps</li> <li>* Shipped without battery electrolyte pre-charged and ready to install</li> <li>* Replaces none battery</li> </ul>		

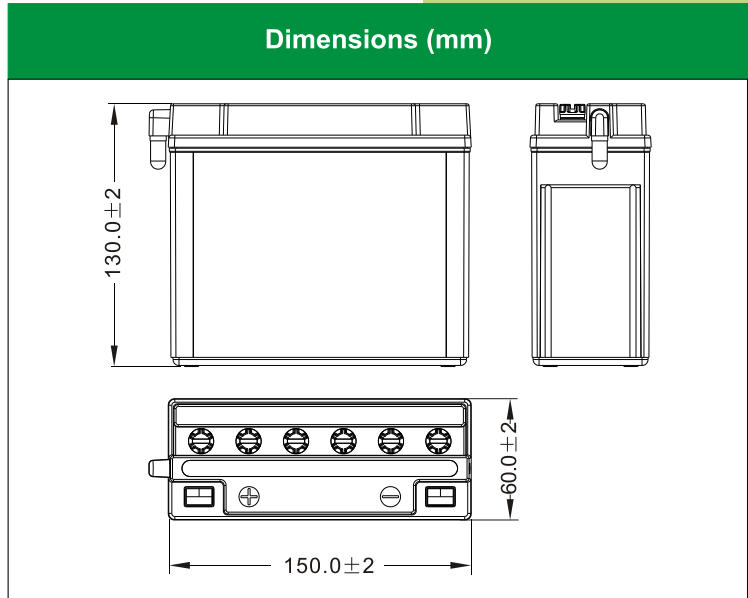
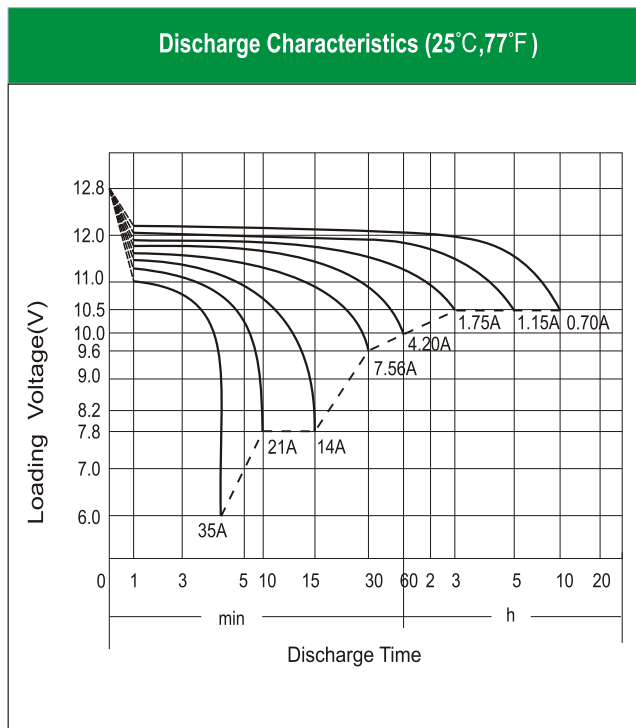

### Electrical Specification

Rated Capacity	10 hour rate (0.70A)	7.00AH
	5 hour rate (1.15 A)	5.74AH
	2 hour rate (2.45A)	4.90AH
	1 hour rate (4.20 A)	4.20AH
	0.5 hour rate (7.56 A)	3.78AH
Capacity affected by Temperature	40 °C (104 °F)	106%
	25 °C (77 °F)	100%
	0 °C (32 °F)	86%
	-15 °C (5 °F)	65%
Self Discharge	Approximately 12% per month (25°C (77°F))	
Charging Methods	Full Charge	Constant-Voltage Charge: Initial charging current: less than 2.1A Voltage: 14.40 V ~ 15.00 V at 25 °C (77 °F) Charging time: 16 ~24h Constant-Current Charge: Charging current: 0.7A, when charging voltage up to 15.60V, continue to charge 2h.
	Floating Charge	No limit on Initial charging current Voltage: 13.50 V ~ 13.80 V at 25 °C (77 °F)