

12N4-3B (12V4Ah)

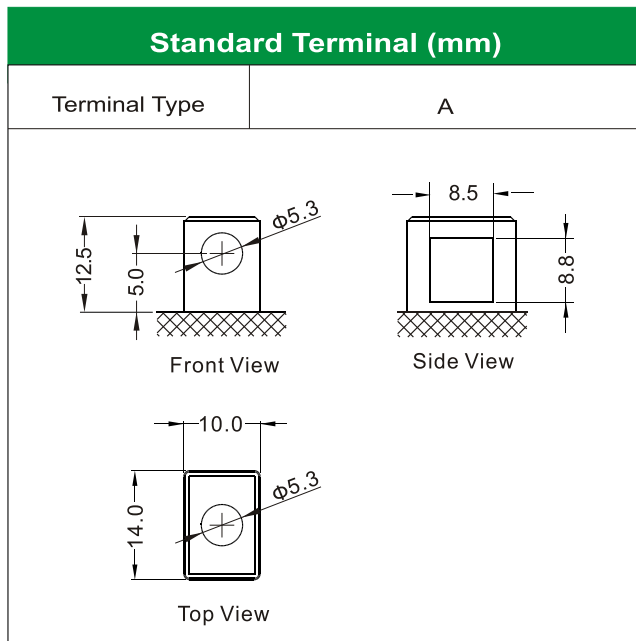
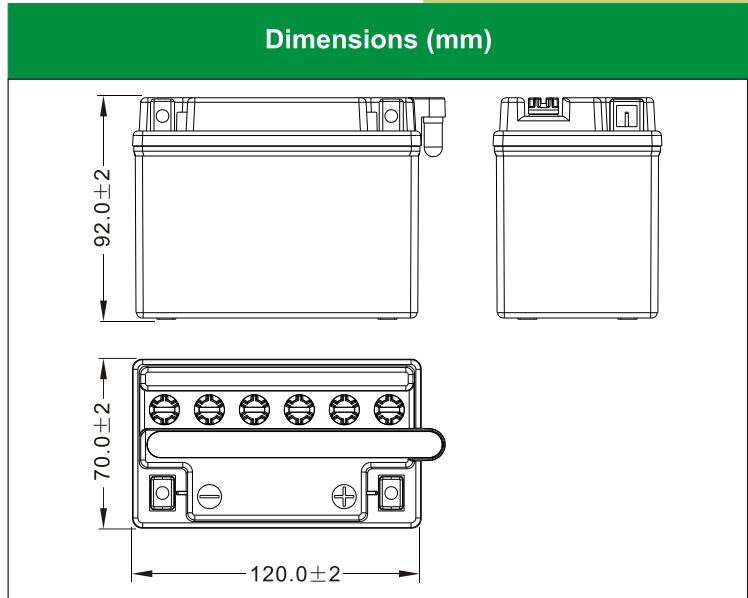
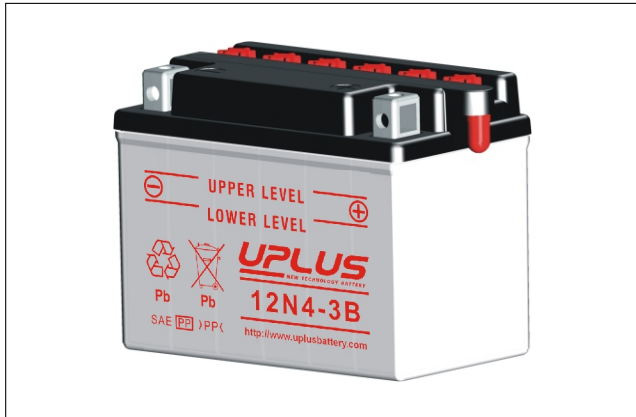

Physical Specification

Nominal Voltage	12V	
Nominal Capacity (10HR)	4AH	
Dimension	Length	120 ± 2mm (4.72 inches)
	Width	70 ± 2mm (2.76 inches)
	Container Height	92 ± 2mm (3.61 inches)
	Total Height (with Terminal)	92 ± 2mm (3.61 inches)
Weight	Battery(with acid):	Approx 1.61kg (3.55lbs)
	Electrolyte:	Approx 0.35kg (0.77lbs)

- * High performance and dry charged high quality and flooded battery
- * Low maintenance
- * Powerful 30 cold cranking amps
- * Shipped without battery electrolyte pre-charged and ready to install
- * Replaces none battery

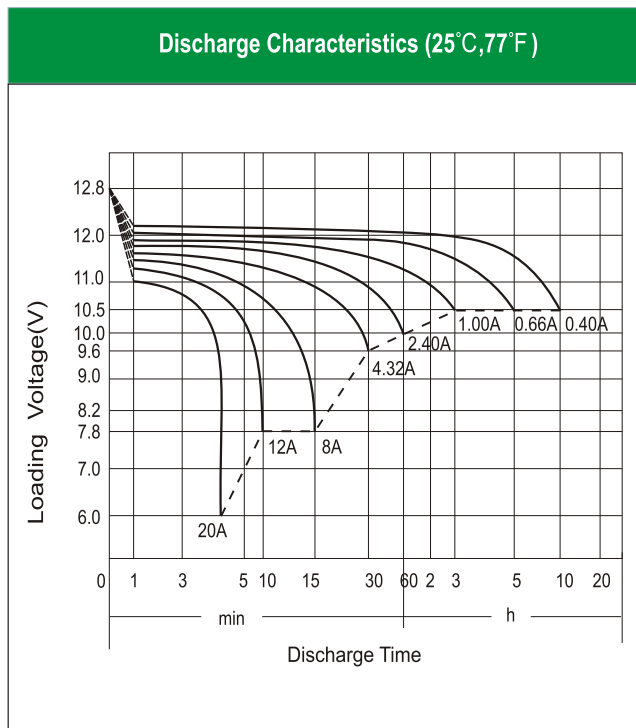

Electrical Specification

Rated Capacity	10 hour rate (0.40A)	4.00AH
	5 hour rate (0.66 A)	3.28AH
	2 hour rate (1.40 A)	2.80AH
	1 hour rate (2.40 A)	2.40AH
	0.5 hour rate (4.32 A)	2.16AH
Capacity affected by Temperature	40 °C (104 °F)	106%
	25 °C (77 °F)	100%
	0 °C (32 °F)	86%
	-15 °C (5 °F)	65%
Self Discharge	Approximately 12% per month (25°C (77°F))	
Charging Methods	Full Charge	Constant-Voltage Charge: Initial charging current: less than 1.2A Voltage: 14.40 V ~ 15.00 V at 25 °C (77 °F) Charging time: 16 ~24h Constant-Current Charge: Charging current: 0.4A, when charging voltage up to 15.60V, continue to charge 2h.
	Floating Charge	No limit on Initial charging current Voltage: 13.50 V ~ 13.80 V at 25 °C (77 °F)