

12N24-4 [12V24Ah]

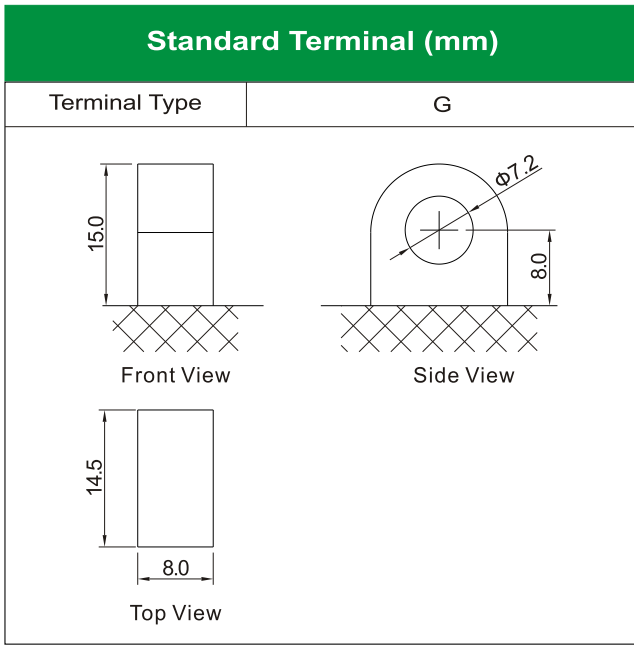
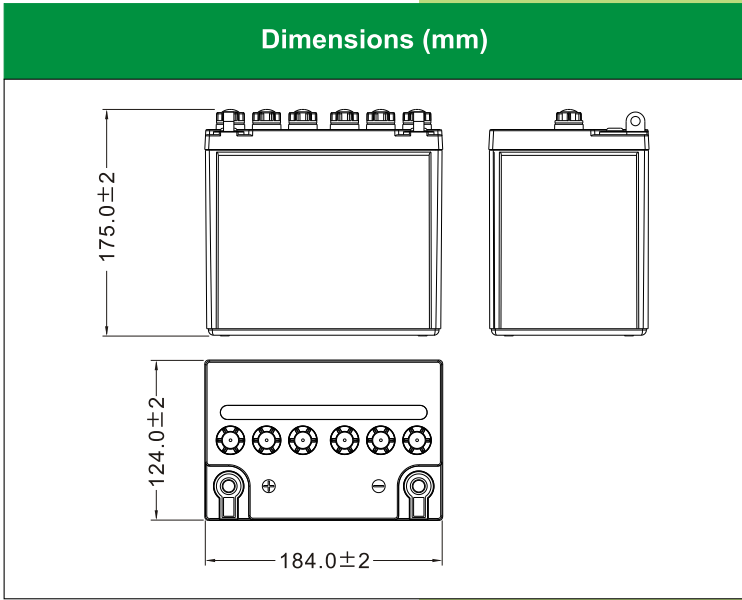

Physical Specification

Nominal Voltage	12V	
Nominal Capacity (10HR)	24AH	
Dimension	Length	184 ± 2mm (7.24 inches)
	Width	124 ± 2mm (4.88 inches)
	Container Height	175 ± 2mm (6.89 inches)
	Total Height (with Terminal)	175 ± 2mm (6.89 inches)
Weight	Battery(with acid): Approx 7.66kg (16.87lbs)	
	Electrolyte: Approx 2.33kg (5.13lbs)	

- * High performance and dry charged high quality and flooded battery
- * Low maintenance
- * Powerful 218 cold cranking amps
- * Shipped without battery electrolyte pre-charged and ready to install
- * Replaces none battery

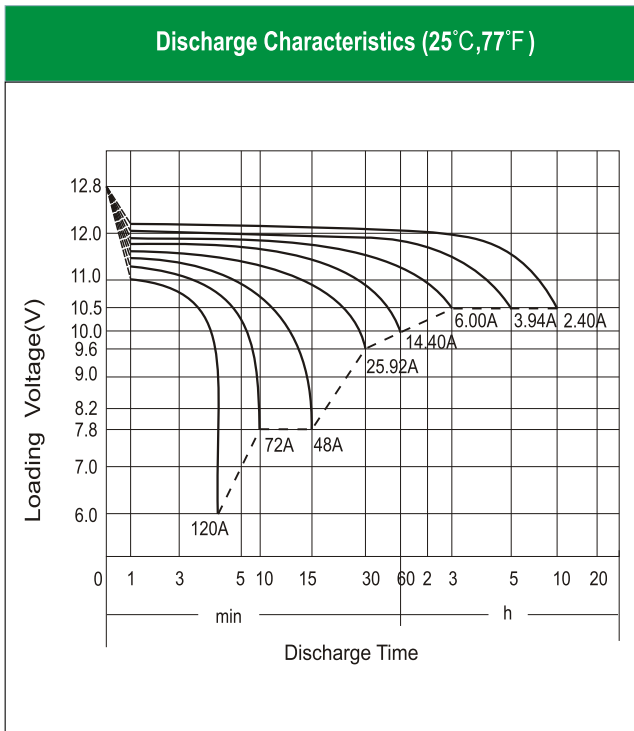

Electrical Specification

Rated Capacity	10 hour rate (2.40A)	24.00AH
	5 hour rate (3.94 A)	19.68AH
	2 hour rate (8.40A)	16.80AH
	1 hour rate (14.40 A)	14.40AH
	0.5 hour rate (25.92A)	12.96AH
Capacity affected by Temperature	40 °C (104 °F)	106%
	25 °C (77 °F)	100%
	0 °C (32 °F)	86%
	-15 °C (5 °F)	65%
Self Discharge	Approximately 12% per month (25°C (77°F))	
Charging Methods	Full Charge	Constant-Voltage Charge: Initial charging current: less than 7.2A Voltage: 14.40 V ~ 15.00 V at 25 °C (77 °F) Charging time: 16 ~24h Constant-Current Charge: Charging current: 2.4A, when charging voltage up to 15.60V, continue to charge 2h.
	Floating Charge	No limit on Initial charging current Voltage: 13.50 V ~ 13.80 V at 25 °C (77 °F)