

Physical Specification (mm)

Nominal Voltage		12V
Nominal Capacity(20HR)		23Ah
Dimension	Length	196 ± 2mm(7.72inches)
	Width	132 ± 2mm(5.20inches)
	Container Height	159 ± 2mm(6.26inches)
	Total Height(with Terminal)	185 ± 2mm(7.28inches)
Weight With Acid		Approx 7.9Kg(17.38lbs)
Acid		1.280 ± 0.015g/cm ³ (25°C)
Standard Terminal		4
Cell layout		0
Hold-Down		B0
Case		Black-Material (PP)
Cover		Black-Material (PP)
Handle		Black-Material (PP)

Dimensions (mm)

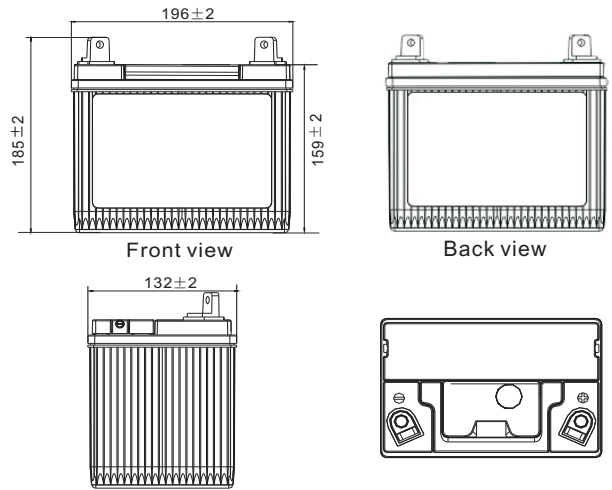

Electrical Specification

Rated Capacity	20 hour rate	23Ah
Reserve Capacity (25A@10.5V)		32min
Cold Cranking Performance Amps(CCA) @0°F(-18°C)		300A

Terminal

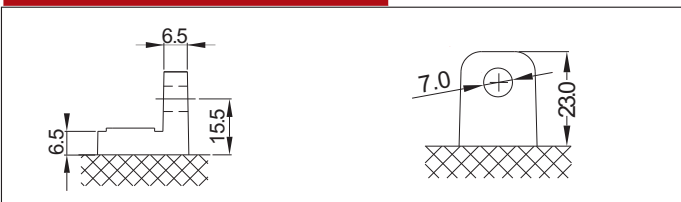

Cell Layout

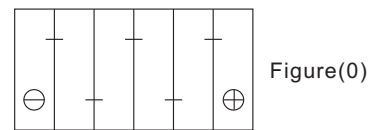

Discharge Characteristics

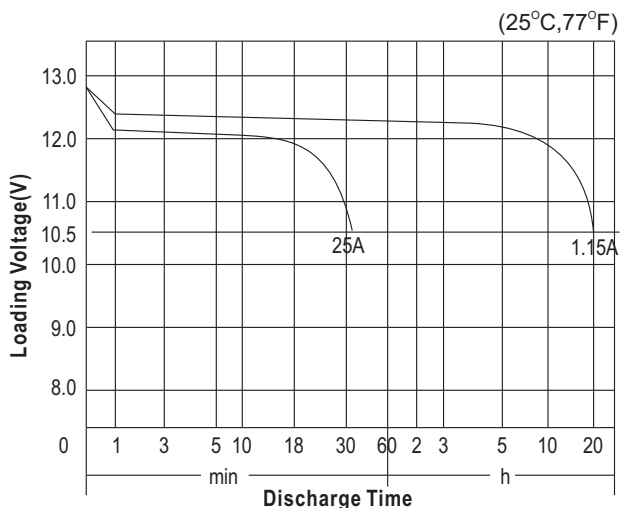

Discharge Characteristics

